

# ICOM

## INSTRUCTION MANUAL

VHF MARINE TRANSCEIVER

# IC-M87

CE 0081   
II 2G Ex ib II A T3 Gb

Icom Inc.

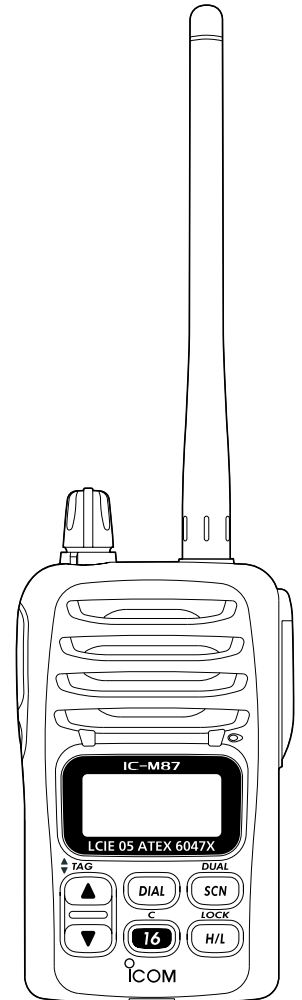

---

## IN CASE OF EMERGENCY

---

If your vessel requires assistance, contact other vessels and the Coast Guard by sending a distress call on Channel 16.

○ **USING CHANNEL 16**

### **DISTRESS CALL PROCEDURE**

1. "MAYDAY MAYDAY MAYDAY"
2. "THIS IS ....." (name of vessel)
3. Your call sign or other indication of the vessel.
4. "LOCATED AT ....." (your position)
5. The nature of the distress and assistance required.
6. Any other information which might facilitate the rescue.

---

## RECOMMENDATION

---

**CLEAN THE TRANSCEIVER THOROUGHLY WITH FRESH WATER** after exposure to saltwater. Otherwise, the transceiver's keys, switches and controllers may become inoperable due to salt crystallization.

**NOTE: DO NOT** wash the transceiver in water if there is any reason to suspect the waterproofing may not be effective. For example, in cases where the battery pack rubber seal is damaged, the transceiver/battery pack is cracked or broken, or has been dropped, or when the battery pack is detached from the transceiver.

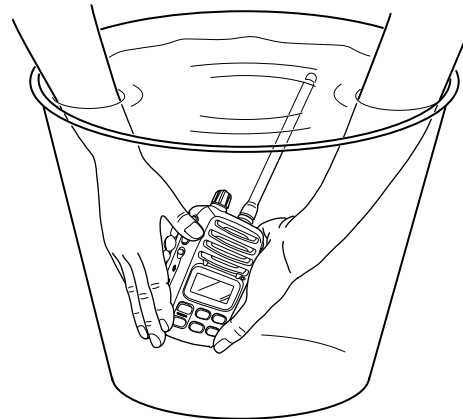

---

## FOREWORD

---

Thank you for purchasing this Icom product. The IC-M87 VHF MARINE TRANSCEIVER is designed and built with Icom's state of the art technology and craftsmanship. With proper care this product should provide you with years of trouble-free operation.

---

## IMPORTANT

---

**READ ALL INSTRUCTIONS** carefully and completely before using the transceiver.

**SAVE THIS INSTRUCTION MANUAL**—This instruction manual contains important operating instructions for the IC-M87.

---

## EXPLICIT DEFINITIONS

---

WORD	DEFINITION
<b>⚠ DANGER!</b>	Personal death, serious injury or an explosion may occur.
<b>⚠ WARNING!</b>	Personal injury, fire hazard or electric shock may occur.
<b>CAUTION</b>	Equipment damage may occur.
<b>NOTE</b>	If disregarded, inconvenience only. No risk of personal injury, fire or electric shock.

---

## FEATURES

---

### **22 free channels for PMR use**

The IC-M87 has 22 free channels reserved for PMR use (146–174MHz). Wide/narrow channel spacing is programmable for each channel, and CTCSS and DTCS signaling is included.

\*Appropriate license will be required.

### **Tough waterproof construction**

The IC-M87 is built tough to withstand hazardous and inhospitable environments at sea and on land. Even if the IC-M87 is dropped into water, its waterproofing\* will protect it from harm. The compact and durable body meets the military specifications (MIL-STD).

\* Equivalent to JIS waterproof grade 7 or IPX7 of the corresponding International Standard IEC 529 (1989). (1m depth for 30 minutes)

### **Simple operation**

6 clearly labelled buttons on the front panel and the volume/power knob maximize simplicity of operation. Even when wearing gloves, the large buttons are easy to operate. A large, clear LCD with backlighting and backlit buttons make night time operation simple.

---

## PRECAUTIONS

---

**⚠ DANGER!** Use and charge only specified Icom battery packs with Icom radios or Icom chargers. Only Icom battery packs are tested and approved for use with Icom radios or charged with Icom chargers. Using third-party or counterfeit battery packs or chargers may cause smoke, fire, or cause the battery to burst.

**⚠ WARNING! NEVER** connect the transceiver to an AC outlet. This may pose a fire hazard or result in an electric shock.

**⚠ WARNING! NEVER** hold the transceiver so that the antenna is very close to, or touching exposed parts of the body, especially the face or eyes, while transmitting. The transceiver will perform best if the microphone is 5 to 10 cm away from the lips and the transceiver is vertical.

**CAUTION: NEVER** connect the transceiver to a power source other than the BP-227AX. Such a connection will ruin the transceiver.

**DO NOT** use or place the transceiver in direct sunlight or in areas with temperatures below  $-15^{\circ}\text{C}$  or above  $+55^{\circ}\text{C}$ : Marine, below  $-25^{\circ}\text{C}$  or above  $+55^{\circ}\text{C}$ : PMR.

**KEEP** the transceiver out of the reach of children.

**KEEP** the transceiver at least 0.9 meter away from your vessel's magnetic navigation compass.

**BE CAREFUL!** The transceiver meets IPX7\* requirements for waterproof protection. However, once the transceiver has been dropped, waterproof protection cannot be guaranteed because of possible damage to the transceiver's case or the waterproof seal.

\* Only when the BP-227AX, flexible antenna, [SP MIC] jack cover is attached.

**MAKE SURE** the flexible antenna and battery pack are securely attached to the transceiver, and that the antenna and battery pack are dry before attachment. Exposing the inside of the transceiver to water will result in serious damage to the transceiver.

After exposure to water, clean the battery contacts thoroughly with fresh water and dry them completely to remove any water or salt residue.

Icom, Icom Inc. and Icom logo are registered trademarks of Icom Incorporated (Japan) in Japan, the United States, United Kingdom, Germany, France, Spain, Russia and/or other countries.

---

# TABLE OF CONTENTS

---

IN CASE OF EMERGENCY .....	i
RECOMMENDATION .....	i
FOREWORD .....	ii
IMPORTANT .....	ii
EXPLICIT DEFINITIONS .....	ii
FEATURES .....	ii
PRECAUTIONS .....	iii
TABLE OF CONTENTS .....	iv
INTRINSIC SAFETY .....	v
<b>1 OPERATING RULES .....</b>	<b>1</b>
<b>2 SUPPLIED ACCESSORIES AND ATTACHMENTS .....</b>	<b>2</b>
<b>3 PANEL DESCRIPTION .....</b>	<b>4–7</b>
■ Front, top and side panels .....	4
■ Function display .....	6
<b>4 BASIC OPERATION .....</b>	<b>8–12</b>
■ Channel selection .....	8
■ Receiving and transmitting .....	10
■ Adjusting the squelch level .....	11
■ Automatic backlighting .....	11
■ Lock function .....	11
■ Call channel programming .....	12
■ Voice scrambler operation .....	12
<b>5 SCAN OPERATION .....</b>	<b>13–14</b>
■ Scan types .....	13
■ Setting TAG channels .....	14
■ Starting a scan .....	14
<b>6 DUALWATCH/TRI-WATCH .....</b>	<b>15</b>
■ Description .....	15
■ Operation .....	15
<b>7 LAND (PMR) CHANNEL OPERATION .....</b>	<b>16</b>
■ LAND (PMR) Channel Group .....	16
■ Function display .....	16
<b>8 SET MODE .....</b>	<b>17–21</b>
■ Set mode programming .....	17
■ Set mode items .....	18
<b>9 BATTERY CHARGING .....</b>	<b>22–25</b>
■ Battery charging .....	22
■ Cautions .....	22
■ AD-100 installation .....	24
■ Optional battery chargers .....	25
<b>10 SPEAKER-MICROPHONE .....</b>	<b>26</b>
■ HM-138 Description .....	26
■ Attachments .....	26
<b>11 TROUBLESHOOTING .....</b>	<b>27</b>
<b>12 VHF MARINE CHANNEL LIST .....</b>	<b>28</b>
<b>13 SPECIFICATIONS .....</b>	<b>29</b>
<b>14 OPTIONS .....</b>	<b>30</b>
<b>15 QUICK REFERENCE .....</b>	<b>31</b>
<b>16 DOC .....</b>	<b>32</b>
<b>17 ATEX CAUTIONS .....</b>	<b>33</b>

# INTRINSIC SAFETY



Versions of the IC-M87 which display the “EX” marking on the serial number seal.

The approval rating for these models is II 2G Ex ib II A T3 Gb.

**WARNING! NEVER** charge the BP-227AX (with/without the transceiver) in an explosive atmosphere. The optional battery chargers are not approved as Intrinsically Safe.

When the transceiver is used in a hazardous area, the BP-227AX **MUST** be attached, either the jack cover or HM-138 **MUST** be attached to the speaker-microphone connector.

**KEEP** the transceiver and the BP-227AX clean to avoid any risk of ignition due to the build-up of electrostatic charges.

Repair of Icom radios should only be carried out by authorized Icom distributors. In particular, repair of ATEX approved radios can **ONLY** be done by Icom to maintain the intrinsically safe rating. **NEVER** attempt to repair an ATEX approved radio. Only Icom has the repair expertise and procedures to maintain the ATEX approval. Contact your Icom distributor or authorised dealer for details.

The ATEX standard is described on the 94/9/EC sticker (Ex Marking) and BP-227AX as below.

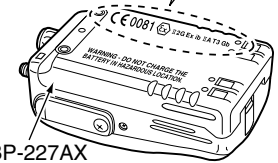
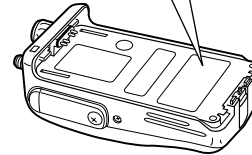
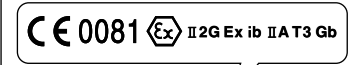

BP-227AX

- **DO NOT OPEN WHEN AN EXPLOSIVE ATMOSPHERE MAY BE PRESENT.**
- **DO NOT CHARGE THE BATTERY IN HAZARDOUS LOCATION.**

The equipment can be used without the microphone but with the jack cover.

## ◇ **Priorities**

- Read all rules and regulations pertaining to priorities and keep an up-to-date copy handy. Safety and distress calls take priority over all others.
- You must monitor Channel 16 when you are not operating on another channel.
- False or fraudulent distress calls are prohibited under law.

## ◇ **Privacy**

- Information overheard but not intended for you cannot lawfully be used in any way.
- Indecent or profane language is prohibited.

## ◇ **Radio licenses**

### **(1) SHIP STATION LICENSE**

When your craft is equipped with a VHF FM transceiver, you must have a current radio station license before using the transceiver. It is unlawful to operate a ship station which is not licensed.

Inquire through your dealer or the appropriate government agency for a Ship-Radiotelephone license. This license includes the call sign which is your craft's identification for radio purposes.

### **(2) OPERATOR'S LICENSE**

A restricted Radiotelephone Operator Permit is the license most often held by small vessel radio operators when a radio is not required for safety purposes.

The Restricted Radiotelephone Operator Permit must be posted near the transceiver or be kept with the operator. Only a licensed radio operator may operate a transceiver.

However, non-licensed individuals may talk over a transceiver if a licensed operator starts, supervises, ends the call and makes the necessary log entries.

A current copy of the applicable government rules and regulations is only required to be on hand for vessels in which a radio telephone is compulsory. However, even if you are not required to have these on hand it is your responsibility to be thoroughly acquainted with all pertinent rules and regulations.

# SUPPLIED ACCESSORIES AND ATTACHMENTS

## ◇ Supplied accessories

The following accessories are supplied:

	Qty.
• Swivel belt clip . . . . .	1
• Stopper for the swivel belt clip . . . . .	1
• Screws for the swivel belt clip . . . . .	2
• Flexible antenna . . . . .	1
• Handstrap . . . . .	1
• Battery pack . . . . .	1
• AC adapter* . . . . .	1
• Battery charger . . . . .	1

\*Not supplied with some version

## ◇ Swivel belt clip

To attach:

① Attach the stopper to the back of the transceiver.

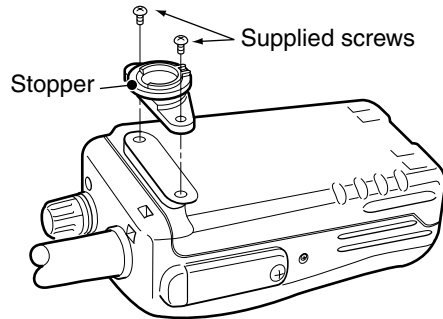

② Clip the belt clip to a part of your belt and insert the stopper to the belt clip.

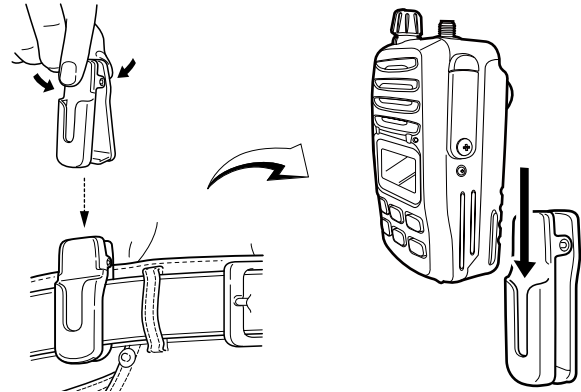

③ Once the transceiver is locked in place, it will swivel 360 degrees.

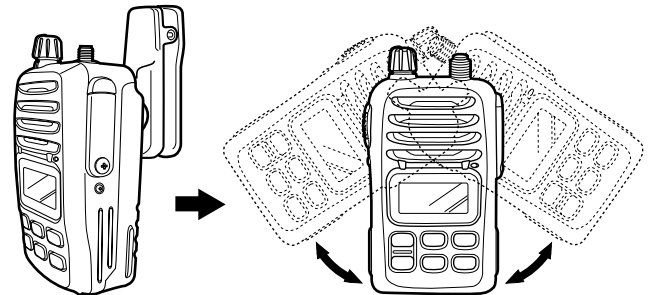



*To remove:*

Turn the transceiver upside down, and then lift up to release the transceiver from the belt clip.

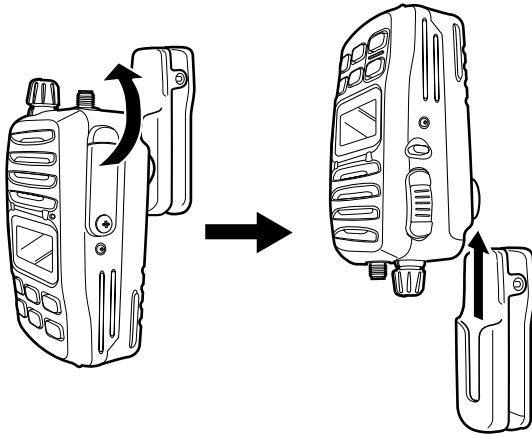

**CAUTION:**  
**HOLD THE TRANSCEIVER TIGHTLY, WHEN ATTACHING OR REMOVING THE TRANSCEIVER FROM THE BELT CLIP.**

If the transceiver is accidentally dropped and the swivel belt clip's stopper is scratched or damaged, the swivel belt clip may not work properly.

◇ **Flexible antenna**

Connect the supplied flexible antenna to the antenna connector.

**CAUTION:**

- **NEVER** carry the transceiver by holding the antenna.
- Transmitting without an antenna may damage the transceiver.

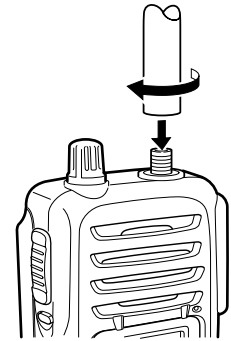

◇ **Handstrap**

Pass the handstrap through the loop on the back side of the transceiver as illustrated at right. This facilitates carrying.

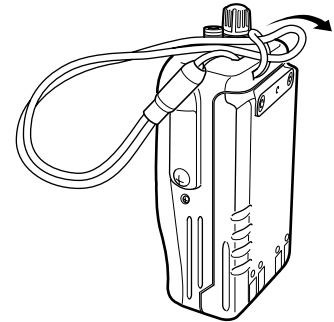

# 3

## PANEL DESCRIPTION

### ■ Front, top and side panels

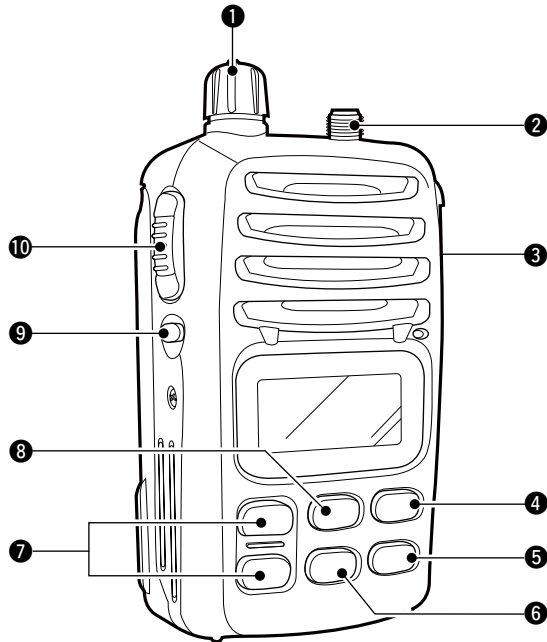

#### ① VOLUME CONTROL [VOL]

Turns power ON and adjusts the audio level.

#### ② ANTENNA CONNECTOR (p. 3)

Connects the supplied antenna.

#### ③ SPEAKER-MICROPHONE CONNECTOR [SP MIC] (p. 26)

Connects the optional speaker-microphone.



[SP MIC] jack cover

**NOTE:** KEEP the [SP MIC] jack cover attached to the transceiver when the speaker-microphone is not in use.

#### ④ SCAN [SCN•DUAL]

- Starts and stops normal or priority scan. (p. 14)
- Enters watch mode when pushed for 1 sec. (p. 15)

#### ⑤ TRANSMIT POWER/LOCK SWITCH [H/L•LOCK]

- Selects high, middle (except for the German version) or low power when pushed. (p. 10)
- Toggles the lock function ON/OFF when pushed for 1 sec. (p. 11)

#### ⑥ CHANNEL 16 SWITCH [16•C]

- Selects Channel 16 when pushed. (p. 8)
- Selects the call channel when pushed for 1 sec. (p. 8)
- Enters call channel write mode when the call channel is selected and this switch is pushed for 3 sec. (p. 12)

**7 CHANNEL UP/DOWN SWITCHES [▲]/[▼]**

- Select an operating channel. (p. 9)
- Selects the set mode condition of item. (p. 17)
- Checks TAG channels or changes scanning direction during scan. (p. 14)
- Sets and clears the displayed channel as a TAG (scanned) channel when pushed both switches for 1 sec.
- While turning power ON, clears all TAG channels in the selected channel group when both switches are pushed.

**8 DIAL/CHANNEL GROUP SWITCH [DIAL]**

- Selects one of 3 regular channels in sequence when pushed for 1 sec. (pp. 8, 9, 16)
  - International, USA (or ATIS\*) and LAND (PMR) channels are available. \*German version only
- Push to return to the condition before selecting the channel when the priority channel or the call channel is selected.

**9 SQUELCH SWITCH [SQL] (p. 11)**

- Push this switch, then set the squelch level with [▲]/[▼].
- Manually opens the squelch for channel monitoring while pushed and held.
- While pushing this switch, turn the power ON to enter the set mode.

**10 PTT SWITCH [PTT]**

Push and hold to transmit; release to receive.

**◇ BATTERY PACK RELEASE BUTTON**

*To release the battery pack:*

Push the battery release button in the direction of the arrow (1) as shown below. The battery pack is then released.

*To attach the battery pack:*

Slide the battery pack on the back of the transceiver in the direction of the arrow (2), then lock it with the battery release button.

\*Slide the battery pack until the battery release button makes a 'click' sound.

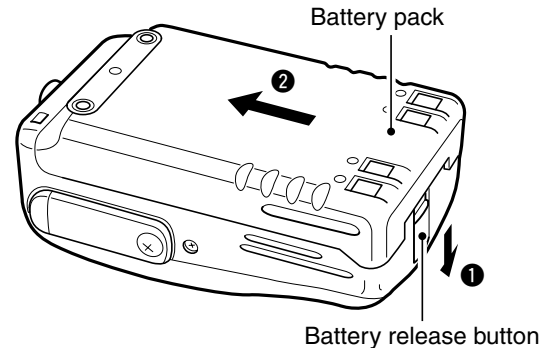

**CAUTION:** When pushing the battery release button, slide the battery pack slightly in the direction of the arrow (2) to ease release. This will prevent possible injuring to your fingers or nails

### 3 PANEL DESCRIPTION

#### ■ Function display

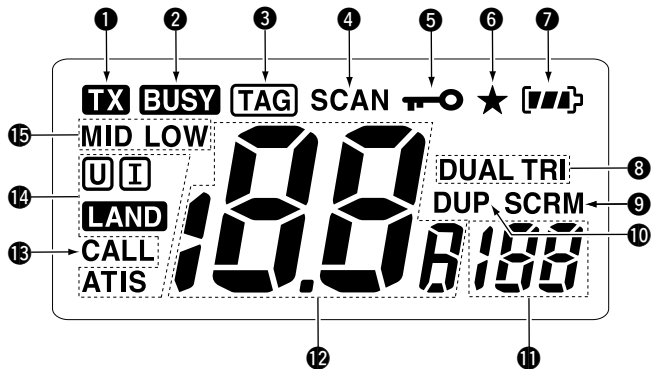

**1 TRANSMIT INDICATOR** (p. 10)  
Appears while transmitting.

**2 BUSY INDICATOR** (p. 10)

- Appears when receiving a signal or when the squelch opens.
- Blinks while monitoring.

**3 TAG CHANNEL INDICATOR** (p. 14)  
Appears when a TAG channel is selected.

**4 SCAN INDICATOR** (p. 14)  
Blinks while scanning.

**5 LOCK INDICATOR** (p. 11)  
Appears while the lock function is activated.

**6 NARROW INDICATOR** (p. 16)  
Appears when narrow channel spacing is selected.  
\*LAND (PMR) channel group only.

**7 BATTERY INDICATOR**  
Indicates remaining battery power.

Indication				
Battery level	Full	Middle	Charging required	Discharged

blinks when the battery is over charged.

**8 DUALWATCH/TRI-WATCH INDICATORS** (p. 15)  
 “DUAL” appears during Dualwatch; “TRI” appears during Tri-watch.

**9 SCRAMBLER INDICATOR**  
 Appears when the optional voice scrambler is activated. (pp. 12, 21)

**10 DUPLEX INDICATOR**  
 Appears when a duplex channel is selected.

**11 SUB CHANNEL READOUT**

- Indicates Channel 16 during priority scan, Dualwatch or Tri-watch. (p. 15)
- Indicates the set mode item while in set mode.

**12 CHANNEL NUMBER READOUT**

- Indicates the selected operating channel number.
- In set mode, indicates the selected condition.

**13 CALL CHANNEL INDICATOR** (p. 8)  
 Appears when the call channel is selected.

**14 CHANNEL GROUP INDICATOR** (pp. 9, 16)  
 “**I**” appears when International; “**U**” appears when U.S.A. (U.K. version only); “**LAND**” appears when LAND (PMR) channel group is selected. “ATIS” appears when the channel group in which ATIS function is activated. (German version only)

**15 TRANSMIT POWER INDICATOR** (p. 10)

- “LOW” appears when low power is selected.
- “MID” appears when middle power is selected. (Except for the German version)
- No indication when high power is selected.

## ■ Channel selection

**IMPORTANT:** Prior to using the transceiver for the first time, the battery pack must be fully charged for optimum life and operation. To avoid damage to the transceiver, turn the power OFF while charging.

### ◇ Channel 16

Channel 16 (Distress channel) is used for establishing initial contact with another station and for emergency communications. Channel 16 is automatically monitored during both Du-alwatch and Tri-watch. While standing by, you must monitor Channel 16.

- ① Push [16•C] to select Channel 16.
- ② Push [DIAL] to return to the condition before selecting Channel 16, or push [▲]/[▼] to select the operating channel.

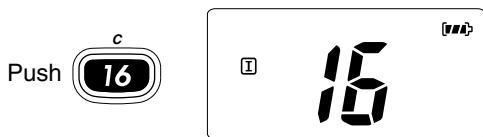

### ◇ Call channel

Each regular channel group has a separate call channel. In addition, each call channel is monitored during Tri-watch. The call channels can be reprogrammed and are used to store your most often used channels in each channel group for quick recall.

- ① Push [16•C] for 1 sec. to select the call channel in the selected channel group.
  - “CALL” and the call channel number appear.
  - Each channel group may have its own call channel after programming a call channel. See the “Call channel programming” on page 12 for details.
- ② Push [DIAL] to return to the condition before selecting the call channel, or push [▲]/[▼] to select the operating channel.

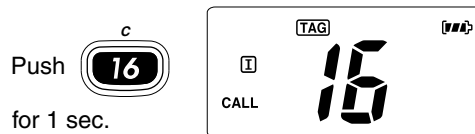

Channel 16 is the default setting.  
(depending on version)

◇ International, U.S.A and ATIS\* channels

There are 57 International, 58 U.S.A. and 57 ATIS\* channels. These channel groups may be specified for the operating area.

- ① Push [DIAL] to select a regular channel.
- ② Push [▲]/[▼] to select a channel.
  - “DUP” appears for duplex channels.
- ③ To change the channel group, push [DIAL] for 1 sec.
  - International, U.S.A. and ATIS\* channels can be selected in sequence. Depending on the setting, LAND (PMR) channel can be selected. See the “LAND (PMR) CHANNEL OPERATION” on page 16 for details.

\* German version only

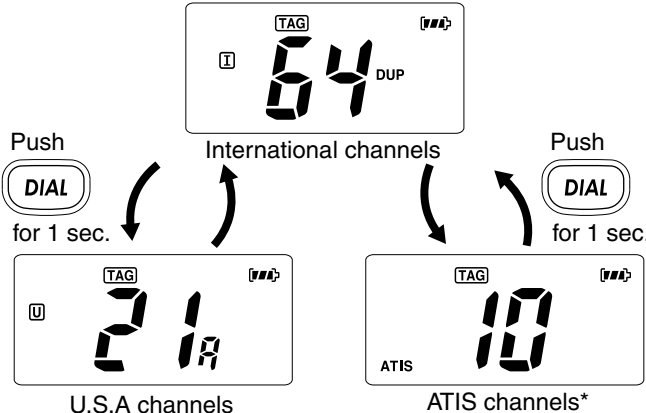

## 4 BASIC OPERATION

### ■ Receiving and transmitting

**CAUTION:** Transmitting without an antenna may damage the transceiver.

- ① Rotate [VOL] clockwise to turn power ON.
- ② Push [SQL] to enter the squelch adjustment mode, then push [▲]/[▼] to set the squelch level.
- ③ Push and hold [SQL] for 1 sec. to open the squelch, then rotate [VOL] to set the volume level while holding down the [SQL] key. (See the set mode item “Monitor switch action” on page 19.)
- ④ Push [▲]/[▼] to select the desired channel.
  - When receiving a signal, “**BUSY**” appears and audio is emitted from the speaker.
  - Further adjustment of [VOL] may be necessary at this point.
- ⑤ Push [H/L•LOCK] to select the output power if necessary.
  - “LOW” appears when low power is selected; “MID” appears when middle power is selected (except for the German version); no indication when high power is selected.
  - Choose low power for short range communications, choose high power for longer distance communications.
  - Some channels are for low power only.
- ⑥ Push and hold [PTT] to transmit, then speak into the microphone.
  - “TX” appears.
  - Channel 70 cannot be used for transmission (for GMDSS use).
- ⑦ Release [PTT] to receive.

**IMPORTANT:** To maximize the readability of your transmitted signal, pause a few sec. after pushing [PTT], hold the microphone 5 to 10 cm from your mouth and speak at a normal voice level.

**NOTE:** The transceiver has a power save function to conserve the battery power and it cannot be turned OFF. The power save function activates automatically when no signal is received for 5 sec.

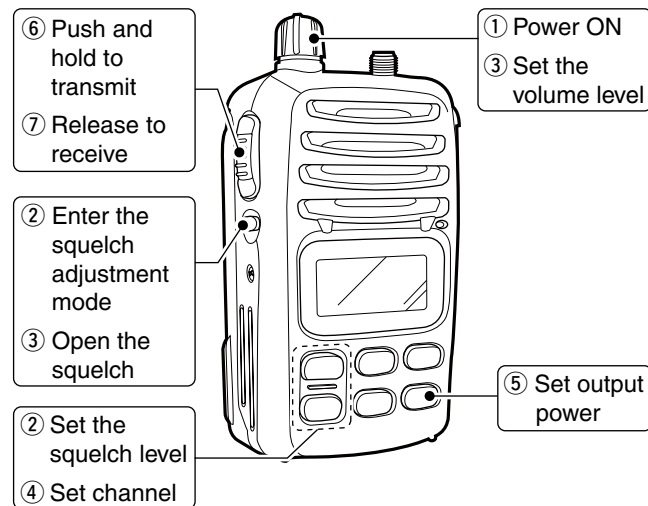



## ■ Adjusting the squelch level

The IC-M87 has a squelch even though there is no control knob for it. In order to receive signals properly, as well as for the scan to function effectively, the squelch must be adjusted to the proper level.

- ① Push [SQL] to enter the squelch adjustment mode, then adjust the squelch level with [▲]/[▼].
  - "SL" indicator appears.
  - There are 11 squelch levels to choose from: OP is completely open; 10 is the tight squelch level.
  - When no key is pushed for 5 sec., the transceiver returns to normal condition.
- ② Push [SQL] again to return to normal condition.

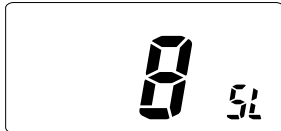

## ■ Automatic backlighting

This function is convenient for nighttime operation. The automatic backlighting can be activated in set mode. (p. 19)

- Push any key except for [PTT] to turn the backlighting ON.
  - The backlighting is automatically turned OFF after 5 sec. of inactivity.

## ■ Lock function

This function electronically locks all keys (except for [PTT], [SQL] and [H/L•LOCK]) to prevent accidental channel changes and function access.

- Push [H/L•LOCK] for 1 sec. to turn the lock function ON and OFF.



Appears while the lock function is used.

## 4 BASIC OPERATION

### ■ Call channel programming

Call channel is used to access Channel 16 (default; may differ according to version), however, you can program the call channel with your most often-used channels in each channel group for quick recall.

- ① Push [DIAL] for 1 sec. several times to select the desired channel group (U.S.A., International and ATIS) to be programmed.
- ② Push [16•C] for 1 sec. to select the call channel.
  - “CALL” and call channel number appear.
- ③ Push [16•C] again for 3 sec. (until a long beep changes to 2 short beeps) to enter call channel programming condition.
  - Call channel number starts blinking.
- ④ Push [▲]/[▼] to select the desired channel.
- ⑤ Push [16•C] to program the displayed channel as the call channel.
  - Call channel number stops blinking.

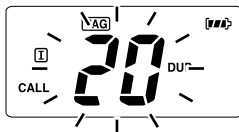

### ■ Voice scrambler operation

#### ◇ Activating the scrambler

The optional voice scrambler provides private communications. In order to receive or send scrambled transmissions, you must first activate the scrambler function.

- ① Select an operating channel except Channel 16 or 70.
- ② While pushing and holding [SQL], push [SCN•DUAL].
  - “SCRM” appears.
- ③ To turn the scrambler function OFF, repeat step ②.
  - “SCRM” disappears.



Appears when the voice scrambler function is in use.

#### ◇ Programming scramble codes

There are 32 codes (1 to 32) available for programming. Set the code in set mode. In order to understand each other, all transceivers in your group must have the same scramble code, as well as the same scrambler unit. See page 21 for scrambler code setting details.

## ■ Scan types

Scanning is an efficient way to locate signals quickly over a wide frequency range. The transceiver has priority scan and normal scan.

In addition, an auto scan function is available for standby convenience. (p. 18)

Set the TAG channels (scanned channel) before scanning. Clear the TAG for unwanted channels which inconveniently stop scanning, such as those for digital communications.

/// Choose priority or normal scan in set mode. (p. 18)

### PRIORITY SCAN

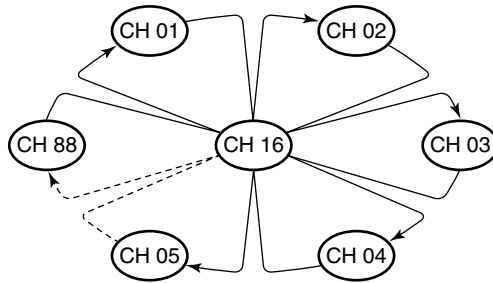

Priority scan searches through all TAG channels in sequence while monitoring Channel 16. When a signal is detected on Channel 16, scan pauses until the signal disappears; when a signal is detected on a channel other than Channel 16, scan becomes Dualwatch until the signal disappears.

### NORMAL SCAN

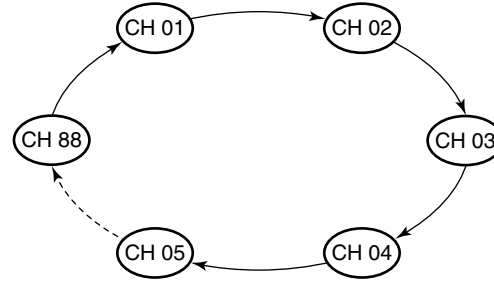

Normal scan, like priority scan, searches through all TAG channels in sequence. However, unlike priority scan, Channel 16 is not checked unless Channel 16 is set as a TAG channel.

## 5 SCAN OPERATION

### ■ Setting TAG channels

For more efficient scanning, add desired channels as TAG channels or clear TAG channels for unwanted channels. Channels that are not tagged will be skipped during scanning. TAG channels can be assigned to each channel group (U.S.A., International and ATIS) independently.

- ① Select the desired channel group by pushing [DIAL] for 1 sec., if desired.
- ② Select the desired channel to set as a TAG channel.
- ③ Push both [▲] and [▼] for 1 sec. to set the displayed channel as a TAG channel.
  - “TAG” appears in the function display.
- ④ To cancel the TAG channel setting, push both [▲] and [▼] for 1 sec.
  - “TAG” disappears.

#### • Clearing all TAG channels in the selected channel group

While pushing and holding both [▲] and [▼], turn power ON to clear all TAG channels in the channel group.

### ■ Starting a scan

Set the priority scan function, scan resume timer and auto scan function in advance, using set mode. (p. 18)

- ① Select the desired channel group by pushing [DIAL] for 1 sec., if desired.
- ② Push [SCN•DUAL] to start priority or normal scan.
  - “SCAN” blinks in the function display.
  - “16” appears during priority scan.
  - When a signal is received, scan pauses until the signal disappears or resumes after pausing 5 sec. according to set mode setting. (Channel 16 is still monitored during priority scan.)
  - Push [▲]/[▼] to check the scanning TAG channels, to change the scanning direction or resume the scan manually.
- ③ To stop the scan, push [SCN•DUAL].
  - “SCAN” disappears.
  - Pushing [PTT], [16•c] or [DIAL] also stops the scan.

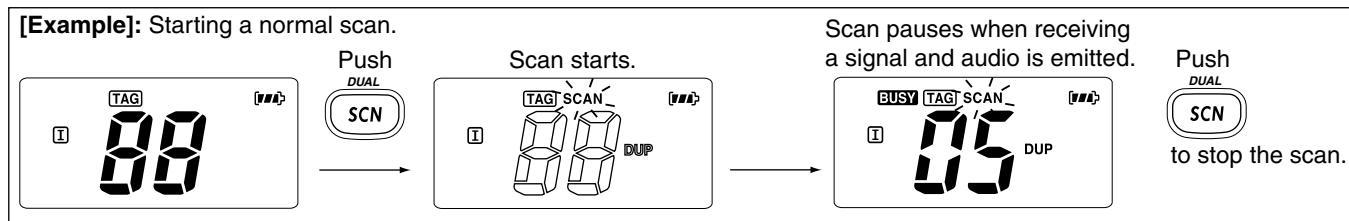

## ■ Description

Dualwatch monitors Channel 16 while you are receiving another channel; Tri-watch monitors Channel 16 and the call channel while receiving another channel. Dualwatch/Tri-watch is convenient for monitoring Channel 16 when you are operating on another channel.

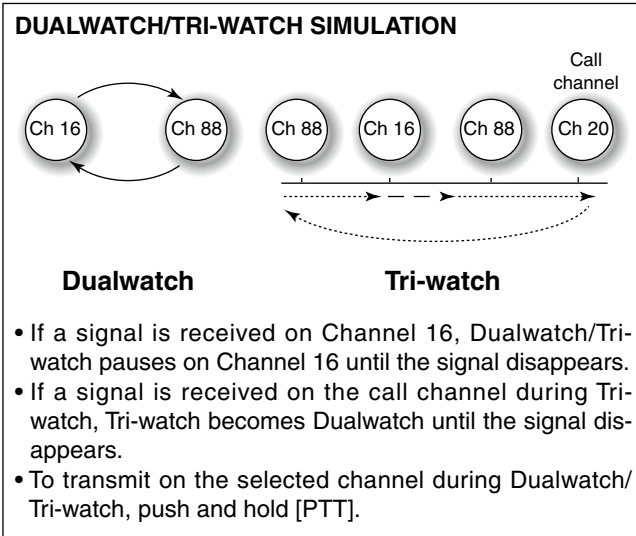

## ■ Operation

- ① Select Dualwatch or Tri-watch in the set mode. (p. 19)
- ② Select the desired operating channel.
- ③ Push [SCN•DUAL] for 1 sec. to start Dualwatch or Tri-watch (depending on set mode setting).
  - “DUAL” blinks during Dualwatch; “TRI” blinks during Tri-watch.
  - A beep tone sounds when a signal is received on Channel 16.
  - Tri-watch becomes Dualwatch when receiving a signal on the call channel.
- ④ To cancel Dualwatch/Tri-watch, push [SCN•DUAL] again.

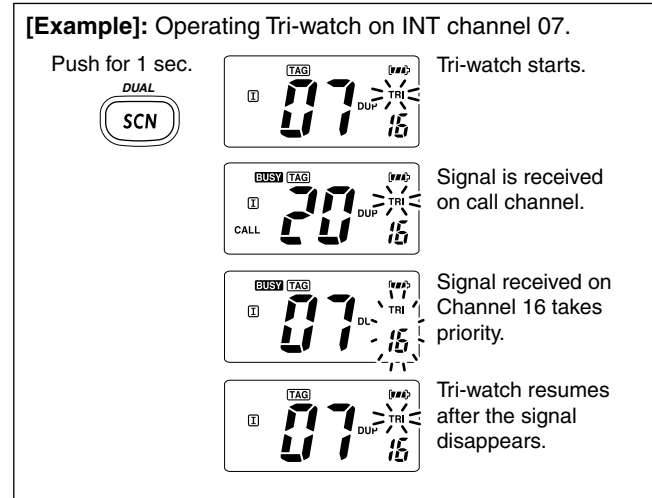

## ■ LAND (PMR) Channel Group

A max. of 22 free LAND mobile channels (allocated 146.000 to 174.000 MHz) can be programmed into the LAND channel group for simple communication with PMR transceivers in the VHF band.

Moreover, any of the marine channels in the INT and USA channel groups can be programmed.

The default setting of the LAND channel group is the same as that of the INT channel group. Ask your local Icom dealer for the LAND channel group setting and PMR frequency programming details.

- ① Push [DIAL] to select a regular channel.
- ② To change the channel group, push [DIAL] for 1 sec. several times.
  - “LAND” appears when LAND (PMR) channel group is selected.
- ③ Push [▲]/[▼] to select a channel.
  - “DUP” appears for duplex channels.

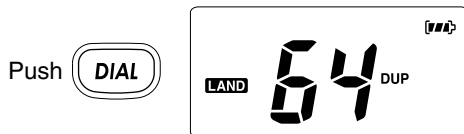

**NOTE:** The basic settings (e.g. call channel programming) are same as the International and U.S.A. channels. Refer to the appropriate pages for details.

## ■ Function display

When Narrow, DTCS or CTCSS is set, the display shows the indications as below.

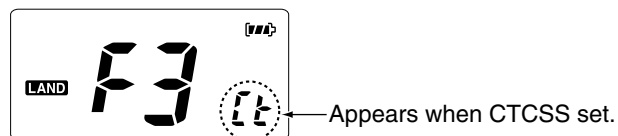
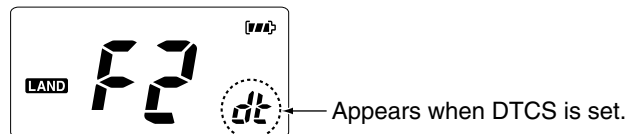
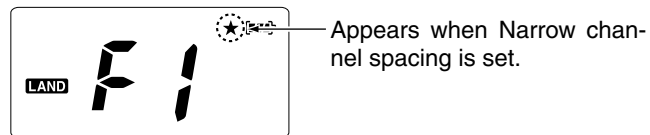

## ■ Set mode programming

set mode is used to change the condition of 12 transceiver functions: Beep tone function, Priority scan function, Scan resume timer, Auto scan function, Dualwatch/Tri-watch function, Monitor switch action, Automatic backlighting, LCD contrast selection, Auto power save function, Self check function, Battery voltage indicator and Scrambler code.

### ◇ SET mode operation

- ① Turn power OFF.
- ② While pushing [SQL], turn power ON to enter set mode.
  - “bp” appears.
- ③ Push [SQL] to select the desired item, if necessary.
- ④ Push [▲]/[▼] to select the desired condition of the item.
- ⑤ To exit set mode, push [16•C].

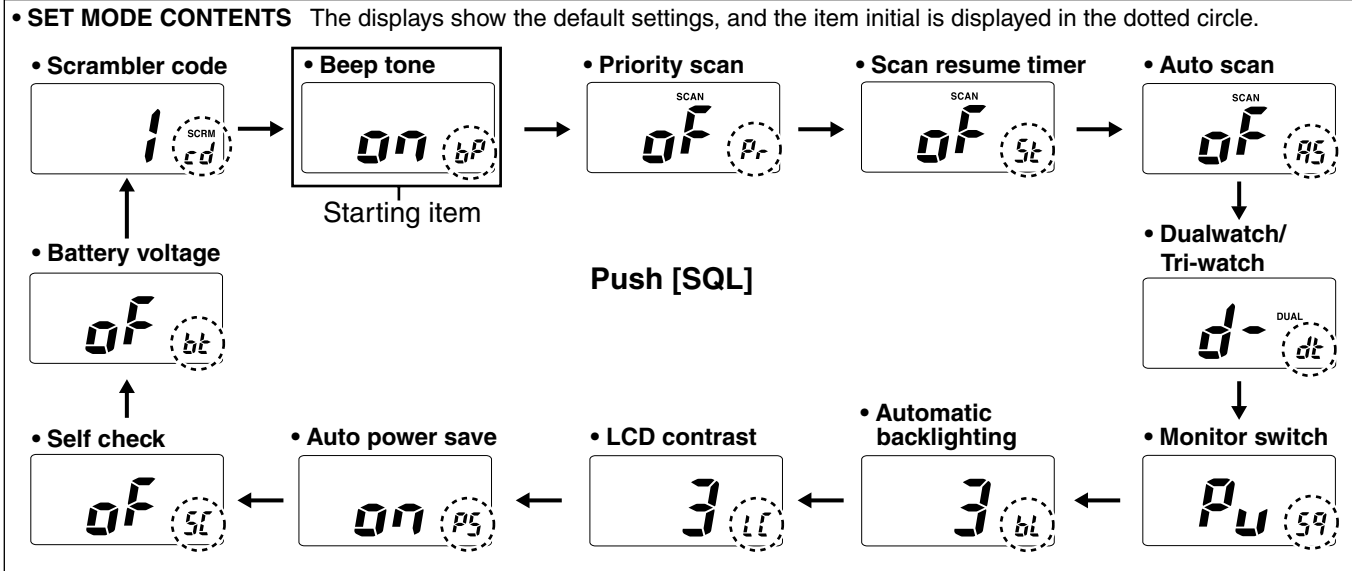

## 8 SET MODE

### ■ Set mode items

#### ◇ Beep tone function “bP”

You can select silent operation by turning the beep tones OFF, or you can have 2 types of confirmation beeps sound at the push of a switch. When ON is selected, a fixed beep (Pi) sounds and when US is selected, the preset beeps (e.g. do, re, mi) sound.



Beep tone ON (default)



User Beep

#### ◇ Priority scan function “Pr”

The transceiver has 2 scan types—normal and priority scans. Normal scan searches all TAG channels in the selected channel group. Priority scan searches all TAG channels in sequence while monitoring Channel 16.



Normal scan (default)

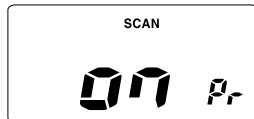

Priority scan

#### ◇ Scan resume timer “St”

The scan resume timer can be set as a pause (OFF) or timer scan (ON).

- OFF : When a signal is detected on a channel, scan pauses on the channel until the signal disappears, and then resumes.
- ON : When a signal is detected on a channel, scan pauses on the channel for 5 sec., and then resumes.



Scan resume timer OFF (default)



Scan resume timer ON

#### ◇ Auto scan function “AS”

The Auto scan function starts the desired scan automatically when no signal is received, or no operation is performed for 30 sec.



Auto scan OFF (default)



Auto scan ON



◇ **Dual/Tri-watch function “dt”**

This item selects Dualwatch or Tri-watch as desired. See page 14 for details.

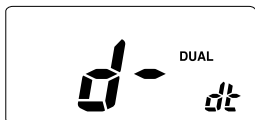

Dualwatch function  
(default)

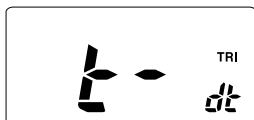

Tri-watch function

◇ **Monitor switch action “Sq”**

The monitor switch action cuts off the squelch function temporarily. This switch action contains PUSH (Pu) or HOLD (Ho) settings as shown below.

- Pu (PUSH) : The monitor function is activated by pushing and holding [SQL] for 1 sec. The squelch opens while holding down the key.
- Ho (HOLD) : The monitor function is activated by pushing and holding [SQL] for 1 sec. The squelch stays open until any key is pushed.



Monitor action PUSH  
(default)



Monitor action Hold

◇ **Automatic backlighting “bl”**

This function is convenient for nighttime operation. The automatic backlighting can be adjusted from OFF, 1 (dark)–3 (bright); 3 (default). Select 1–3 to turn this function ON.

- The automatic backlighting turns the backlighting ON when any key except for [PTT] is pushed.
- The backlighting is automatically turned OFF after 5 sec. of inactivity.



Automatic backlighting  
(default)



Automatic backlighting  
OFF

◇ **LCD contrast selection “LC”**

The contrast of the LCD can be adjusted from 4 levels.

- 1 (bright)–4 (dark); 3 (default)



LCD contrast 3 (default)

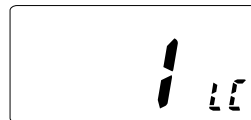

LCD contrast 1

## 8 SET MODE

### ◇ Auto power save function “PS”

The auto power save function reduces current drain by deactivating the receiver circuit for preset intervals.

- OFF : The power save function is turned OFF.
- ON : The power save function is turned ON. The power save function will be activated when no signal is received, and no operation is performed for 5 sec.



Auto power save ON  
(default)



Auto power save OFF

### ◇ Self check function “SC”

The self check function checks transceiver conditions by itself, and informs you in case a problem is found. The following items are checked after the power is turned ON, then it switches to operation mode.

- Temperature : Outside of  $-35^{\circ}\text{C}$  to  $+73^{\circ}\text{C}$  (approx.)
- Connected battery voltage
- Water intrusion



Self check OFF (default)



Self check ON

When error messages as shown below are displayed, see trouble shooting for advice (p. 27).

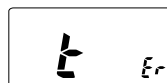

Temperature error



Battery voltage error

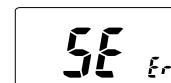

Water intrusion error

◇ **Battery voltage indicator “bt”**

This function contains display or non-display settings of the voltage of the connected battery pack when the power is ON.

- The voltage of the connected battery pack is displayed for 2 sec. after power is turned ON.



Battery voltage OFF  
(default)



Battery voltage ON

◇ **Scrambler code “cd”**

There are 32 codes (1 to 32) available for programming. In order to understand each other, all transceivers in your group must have the same scramble code.

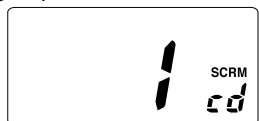

Scrambler code 1 (default)



Scrambler code 32

**SET MODE LIST**

Function	Indication	Switch
Beep tone function	“bP”	OFF / ON* / US
Priority scan function	“Pr”	OFF* / ON
Scan resume timer	“St”	OFF* / ON
Auto scan function	“AS”	OFF* / ON
Dual/Tri-watch function	“dt”	Dual* / Tri
Monitor switch action	“Sq”	Push* / Hold
Automatic backlighting	“bL”	OFF / 1 / 2 / 3*
LCD contrast selection	“LC”	1 / 2 / 3* / 4
Auto power save function	“PS”	OFF / ON*
Self check function	“SC”	OFF* / ON
Battery voltage indicator	“bt”	OFF* / ON
Scrambler code	“cd”	1* / 2 / ... / 32

\* default setting

## ■ Battery charging

Prior to using the transceiver for the first time, the battery pack must be fully charged for optimum life and operation.

**CAUTION:** To avoid damage to the transceiver, turn it OFF while charging.

- Recommended temperature range for charging:  
0°C to +45°C  
- The Li-ion battery is functioning within -10°C to +60°C
- Use the specified chargers (BC-119N, BC-121N and BC-152N). **NEVER** use another manufacturer's charger.
- Use the supplied AC adapter for BC-152N. **NEVER** use another manufacturer's AC adapter.

### **Recommendation:**

Charge the supplied battery pack for a maximum of up to 10 hours. Li-ion batteries are different from Ni-Cd batteries in that it is not necessary to completely charge and discharge them to prolong the battery life. Therefore, charging the battery in intervals, and not for extended periods is recommended.

## ■ Cautions

**⚠ DANGER! NEVER** short the terminals of the battery pack. Also, current may flow into nearby metal objects, such as a necklace, etc. Therefore, be careful when carrying with, or placing near metal objects, carrying in handbags, etc.

**⚠ DANGER! NEVER** use the transceiver or the battery if either one is damaged, shows cracks, bruises or is deformed.

**⚠ WARNING! NEVER** incinerate used battery packs. Internal battery gas may cause an explosion.

**CAUTION: NEVER** immerse the battery pack in water. If the battery pack becomes wet, be sure to wipe it dry immediately (particularly the battery terminals) **BEFORE** attaching it to the transceiver. Otherwise, the terminals will become corroded, or cause connection failure, etc.

**DO NOT** leave the battery pack in a fully charged, or completely discharged condition for long time. It causes shorter battery life. In case of leaving the battery pack unused for a long time, it must be kept safely after discharge, or use the battery until the battery indicator shows the middle level, then remove it from the transceiver.

**BE SURE** to replace the battery with a new one after five years, even if still holds a charge. The inside battery material will deteriorate after a period of time, even with little use.

If your battery pack seems to have no capacity even after being charged, completely discharge it by leaving the power ON overnight. Then, fully charge the battery pack again. If the battery pack still does not retain a charge (or very little), a new battery pack must be purchased.

## ◇ Charging connections

- ① Attach the BC-152N to a flat surface, such as desk or cabin, if desired.
- ② Connect the AC adapter as shown below.
- ③ Insert the battery pack with/without the transceiver into the charger.
  - The charge indicator lights orange while charging.
- ④ Charge the battery pack approximately 10 hours, depending on the remaining power condition.
  - The charge indicator lights green when charging is completed.

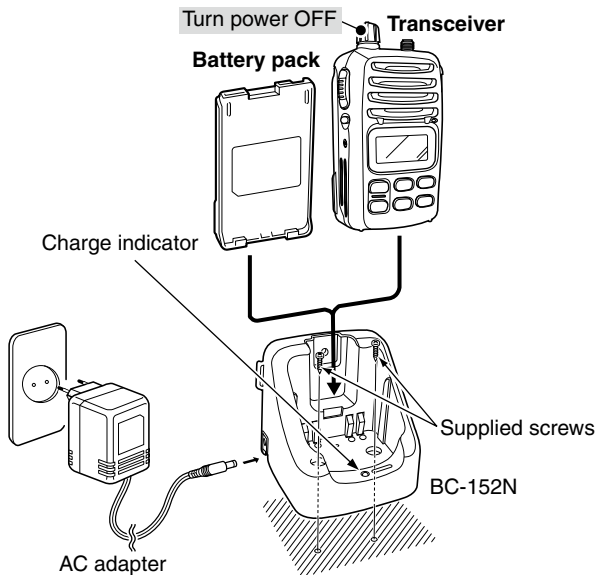

If the charge indicator blinks orange or green, or does not light when a problems is detected.

### /// SOLUTIONS:

- Remove the battery pack, and reinsert it.
- Remove the battery pack, clean the battery terminals, then reinsert it.
- If the battery pack temperature is high, remove and let it cool down, then reinsert it.

If you are unable to solve the problem through the use of these solutions, the battery pack or the charger may be damaged, or the battery life may be over. In that case, contact your nearest Icom Dealer or Service Center.

### /// NOTE:

After charging is completed, the BC-152N will automatically recharge the battery pack when the battery voltage decreases. If the battery pack is often left in the charger for long periods, the battery life cycle will be shorter.

## ◇ For your convenience

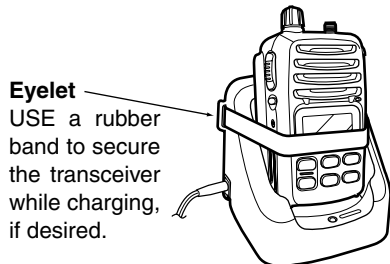

## 9 BATTERY CHARGING

### ■ AD-100 installation

The AD-100 CHARGER ADAPTER must be installed into the BC-119N or BC-121N before battery charging.

- ① Attach the plugs from the BC-119N/BC-121N to the AD-100.
- ② Secure the AD-106 into the holder space of the BC-119N/BC-121N with the supplied screws.

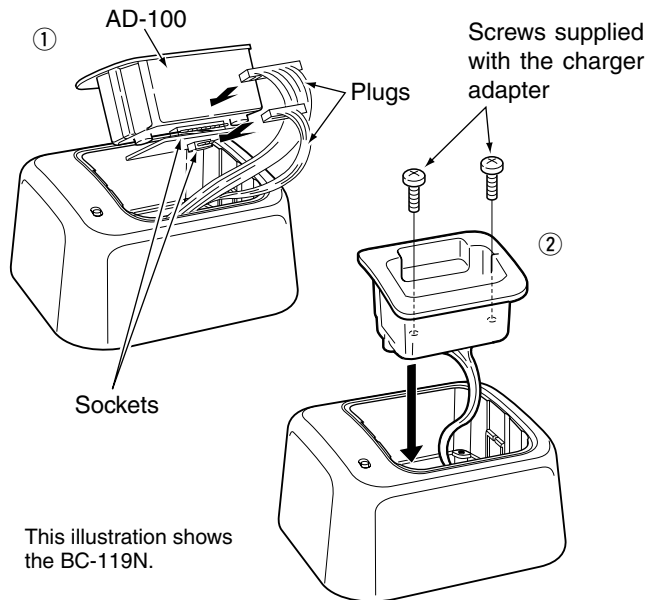

### ■ Optional battery chargers

#### ◇ Rapid charging with the BC-119N+AD-100

The optional BC-119N provides rapid charging of the battery packs. The following are additionally required.

- AD-100 charger adapter
- An AC adapter (may be supplied with BC-119N depending on version).

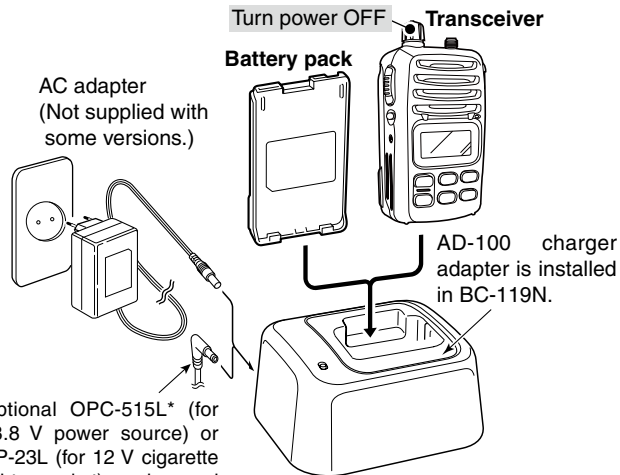

Optional OPC-515L\* (for 13.8 V power source) or CP-23L (for 12 V cigarette lighter socket) can be used instead of the AC adapter.

/// \*CAUTION: NEVER connect the OPC-515L to a power source using reverse polarity. This will ruin the battery charger.  
White line: ⊕ Black line: ⊖

See the instruction manual for details of the charger LED indication, operation, etc.

◇ **Rapid charging with the BC-121N+AD-100**

The optional BC-121N allows up to 6 battery packs to be charged simultaneously. The following are additionally required.

- Six AD-100 charger adapters
- An AC adapter (BC-157) or the DC power cable OPC-656, supplied with the BC-121N.

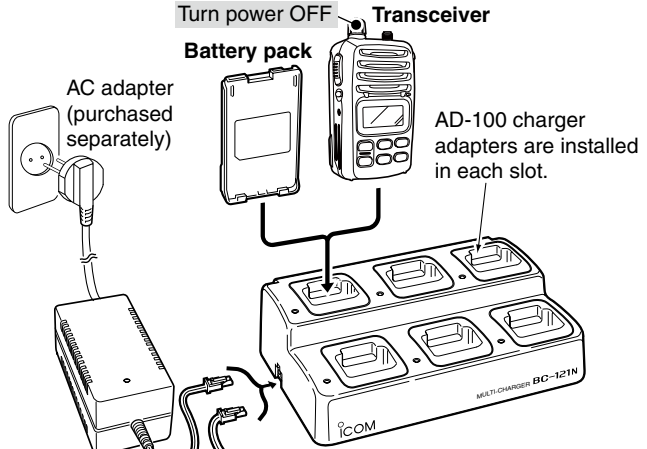

**DC power cable (OPC-656\*)**  
(Connect with a DC power supply;  
13.8 V/at least 7 A)

\*About the OPC-656  
Red line : ⊕ Black line : ⊖

/// **IMPORTANT: Battery charging caution**

Ensure the guide tabs on the battery pack are correctly aligned with the guide rails inside the charger adapter. (This illustration is described with the BC-152N.)

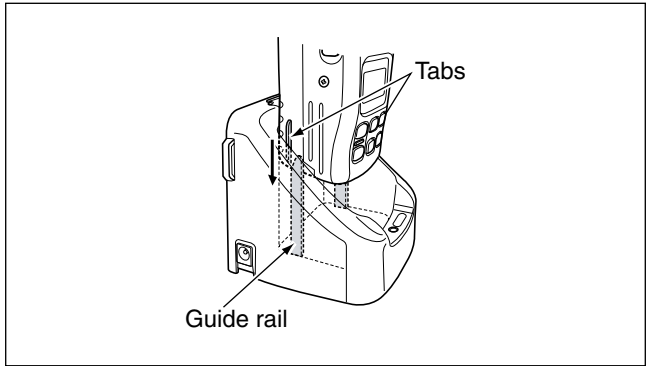

# 10 SPEAKER-MICROPHONE

## ■ HM-138 Description

### Alligator type clip

To attach the speaker-mic.  
to your shirt or collar, etc.

### PTT switch

Transmits during push  
Receives during release

### Microphone

### Speaker

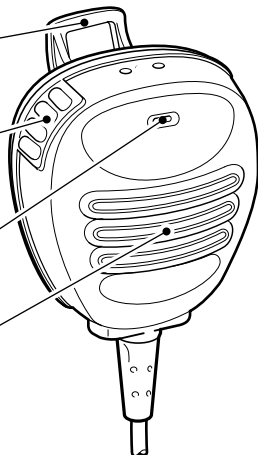

**NEVER** immerse the connector in water. If the connector becomes wet, be sure to dry it **BEFORE** attaching it to the transceiver.

**NOTE:** The microphone is located at the top of the speaker-microphone, as shown in the diagram above. To maximize the readability of your transmitted signal (voice), hold the microphone approx. 5 to 10 cm from your mouth, and speak in a normal voice level.

## ■ Attachments

Insert the connector of the speaker-microphone into the [SP MIC] connector on the transceiver and tighten the screw.

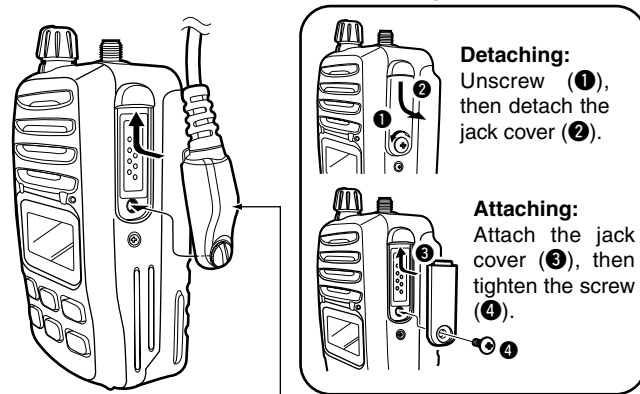

**CAUTION:** Attach the speaker-microphone's connector securely to prevent accidental dropping, or water intrusion in the connector.

**IMPORTANT: KEEP** the [SP MIC] jack cover attached when the speaker-microphone is not in use. If the cover is not attached, water will get into the transceiver. Moreover, the terminals (pins) will become rusty, or the transceiver will function abnormally if the connector gets wet.

**CAUTION:** For ATEX compliance in hazardous areas, the jack cover just also be attached when the HM-138 is not being used.



PROBLEM	POSSIBLE CAUSE	SOLUTION	REF.
The transceiver does not turn ON.	<ul style="list-style-type: none"> <li>• The battery is exhausted.</li> <li>• Bad connection to the battery pack.</li> </ul>	<ul style="list-style-type: none"> <li>• Recharge the battery pack.</li> <li>• Check the connection to the transceiver.</li> </ul>	p. 22 p. 5
No sound from speaker.	<ul style="list-style-type: none"> <li>• Squelch level is too deep.</li> <li>• Volume level is too low.</li> <li>• Speaker has been exposed to water.</li> </ul>	<ul style="list-style-type: none"> <li>• Set squelch to the threshold point.</li> <li>• Set [VOL] to a suitable level.</li> <li>• Drain water from the speaker.</li> </ul>	p. 11 p. 10 —
Transmitting is impossible, or high power cannot be selected.	<ul style="list-style-type: none"> <li>• Some channels are for low power or receive only.</li> <li>• The battery is exhausted.</li> <li>• The output power is set to low.</li> </ul>	<ul style="list-style-type: none"> <li>• Change channels.</li> <li>• Recharge the battery pack.</li> <li>• Push [H/L•LOCK] to select high power.</li> </ul>	pp. 8, 9, 28 p. 22 p. 10
The displayed channel cannot be changed.	<ul style="list-style-type: none"> <li>• Lock function is activated.</li> </ul>	<ul style="list-style-type: none"> <li>• Push [H/L•LOCK] for 1 sec. to cancel the function.</li> </ul>	p. 11
Scan does not start.	<ul style="list-style-type: none"> <li>• “TAG” channels are not programmed.</li> </ul>	<ul style="list-style-type: none"> <li>• Set the desired channels as “TAG” channels.</li> </ul>	p. 14
No beeps.	<ul style="list-style-type: none"> <li>• Beep tones are turned OFF.</li> </ul>	<ul style="list-style-type: none"> <li>• Set the beep tones to ON (Fix Beep/User Beep) in set mode.</li> </ul>	p. 18
Self check error. (Temperature)	<ul style="list-style-type: none"> <li>• The temperature is outside of <math>-35^{\circ}\text{C}</math> to <math>+73^{\circ}\text{C}</math> (approx.)</li> </ul>	<ul style="list-style-type: none"> <li>• Leave the transceiver at room temperature for a while. Turn the power ON to check if the internal temperature has returned to normal.</li> </ul>	—
Self check error. (Battery voltage)	<ul style="list-style-type: none"> <li>• The connected battery pack’s voltage is more than 8.8 V.</li> </ul>	<ul style="list-style-type: none"> <li>• Verify the battery voltage is correct.</li> </ul>	—
Self check error. (Water intrusion)	<ul style="list-style-type: none"> <li>• Water has entered the transceiver.</li> </ul>	<ul style="list-style-type: none"> <li>• Have the transceiver checked at your local distributor or dealer to see whether the transceiver works properly or not.</li> </ul>	—

# 12 VHF MARINE CHANNEL LIST

## • International channels

CH	Frequency (MHz)		CH	Frequency (MHz)		CH	Frequency (MHz)		CH	Frequency (MHz)		CH	Frequency (MHz)		CH	Frequency (MHz)	
	Transmit	Receive		Transmit	Receive		Transmit	Receive		Transmit	Receive		Transmit	Receive		Transmit	Receive
01	156.050	160.650	11	156.550	156.550	21	157.050	161.650	61	156.075	160.675	71	156.575	156.575	81	157.075	161.675
02	156.100	160.700	12	156.600	156.600	22	157.100	161.700	62	156.125	160.725	72	156.625	156.625	82	157.125	161.725
03	156.150	160.750	13	156.650	156.650	23	157.150	161.750	63	156.175	160.775	73	156.675	156.675	83	157.175	161.775
04	156.200	160.800	14	156.700	156.700	24	157.200	161.800	64	156.225	160.825	74	156.725	156.725	84	157.225	161.825
05	156.250	160.850	15	156.750	156.750	25	157.250	161.850	65	156.275	160.875	75	156.775	156.775	85	157.275	161.875
06	156.300	156.300	16	156.800	156.800	26	157.300	161.900	66	156.325	160.925	76	156.825	156.825	86	157.325	161.925
07	156.350	160.950	17	156.850	156.850	27	157.350	161.950	67	156.375	156.375	77	156.875	156.875	87	157.375	157.375
08	156.400	156.400	18	156.900	161.500	28	157.400	162.000	68	156.425	156.425	78	156.925	161.525	88	157.425	157.425
09	156.450	156.450	19	156.950	161.550	37A*	157.850	157.850	69	156.475	156.475	79	156.975	161.575	P4	161.425	161.425
10	156.500	156.500	20	157.000	161.600	60	156.025	160.625	70†	156.525	156.525	80	157.025	161.625			

## • USA channels (for U.K. version only)

CH	Frequency (MHz)		CH	Frequency (MHz)		CH	Frequency (MHz)		CH	Frequency (MHz)		CH	Frequency (MHz)		CH	Frequency (MHz)	
	Transmit	Receive		Transmit	Receive		Transmit	Receive		Transmit	Receive		Transmit	Receive		Transmit	Receive
01A	156.050	156.050	12	156.600	156.600	22A	157.100	157.100	64A	156.225	156.225	77	156.875	156.875	86	157.325	161.925
--	---	---	13	156.650	156.650	23A	157.150	157.150	65A	156.275	156.275	78A	156.925	156.925	86A	157.325	157.325
03A	156.150	156.150	14	156.700	156.700	24	157.200	161.800	66A	156.325	156.325	79A	156.975	156.975	87	157.375	161.975
--	---	---	15	156.750	156.750	25	157.250	161.850	67	156.375	156.375	80A	157.025	157.025	87A	157.375	157.375
05A	156.250	156.250	16	156.800	156.800	26	157.300	161.900	68	156.425	156.425	81A	157.075	157.075	88	157.425	162.025
06	156.300	156.300	17	156.850	156.850	27	157.350	161.950	69	156.475	156.475	82A	157.125	157.125	88A	157.425	157.425
07A	156.350	156.350	18A	156.900	156.900	28	157.400	162.000	70†	156.525	156.525	83A	157.175	157.175	P4*	161.425	161.425
08	156.400	156.400	19A	156.950	156.950	37A*	157.850	157.850	71	156.575	156.575	84	157.225	161.825			
09	156.450	156.450	20	157.000	161.600	61A	156.075	156.075	72	156.625	156.625	84A	157.225	157.225			
10	156.500	156.500	20A	157.000	157.000	--	---	---	73	156.675	156.675	85	157.275	161.875			
11	156.550	156.550	21A	157.050	157.050	63A	156.175	156.175	74	156.725	156.725	85A	157.275	157.275			

† Receive only

\*UK Marina Channels: M1=37A (157.850 MHz), M2=P4 (161.425 MHz) for U.K. version only

## GENERAL

- Frequency coverage
  - Marine TX : 156.000–161.450 MHz
  - RX : 156.000–163.425 MHz
  - PMR TX/RX : 146.000–174.000 MHz
- Mode
  - Marine : 16K0G3E
  - PMR : 16K0F3E\* (Wide)/  
8K50F3E (Narrow)  
\*14K0F3E for German version
- Channel spacing
  - Marine : ±25 kHz
  - PMR : ±25 kHz (Wide)  
±20 kHz (Wide) <German ver.>  
±12.5 kHz (Narrow)
- Current drain (at 7.4 V DC) : TX at 1 W 0.7 A typical  
TX at 0.5 W 0.6 A typical  
Max. audio 200 mA typical  
Power save 20 mA typical
- Frequency stability : ±1.5 kHz (–25°C to +55°C)
- Usable temperature range
  - Marine : –15°C to +55°C
  - PMR : –25°C to +55°C
- Dimensions : 62 (W) × 97(H) × 39(D) mm  
(Projections not included)
- Weight (approx.; with BP-227AX) : 280 g

## TRANSMITTER

- Output power (at 7.4 V DC)
  - Marine : 1/0.5 W
  - PMR : 1 W ALL
- Modulation system : Variable reactance frequency modulation

- Max. frequency deviation
  - Marine : ±5 kHz (Wide)
  - PMR : ±5 kHz (Wide)  
±4 kHz (Wide) <German ver.>  
±2.5 kHz (Narrow)
- Audio harmonics distortion : Less than 10% (at 60% mod.)
- Spurious emissions : 0.25 μW (below 2GHz)  
1 μW (above 2GHz)

## RECEIVER

- Receive system : Double-conversion superheterodyne
- Sensitivity (20 dB SINAD)
  - Marine : –2 dBμ EMF (typical)
  - PMR : –4 dBμ EMF (typical)
- Squelch sensitivity : 0 dBμ EMF (typical)
- Intermodulation rejection ratio
  - Marine : 68 dB
  - PMR : 65 dB
- Spurious response rejection ratio : 70 dB
- Adjacent channel selectivity : 70 dB (Wide)  
60 dB (Narrow; PMR only)
- Hum and noise ratio : 40 dB (Wide)  
34 dB (Narrow; PMR only)
- Audio output power
  - Marine : 0.2 W at 10% distortion with an 8 Ω load
  - PMR : 0.35 W typical at 10% distortion with an 8 Ω load

**All stated specifications are subject to change without notice or obligation.**

# 14 OPTIONS

---

- **BP-227AX** Li-Ion BATTERY PACK  
7.4 V/1850 mAh/14 Wh Li-ion battery pack. The same as supplied with the transceiver. BP-227AX must be charged with the supplied BC-152N or the optional BC-119N/121N.
- **BC-119N** DESKTOP CHARGER + **AD-100** CHARGER ADAPTER + **BC-145S** AC ADAPTER  
For rapid charging of battery packs. An AC adapter is supplied with the charger.  
Charging time: Approximately 2 to 2.5 hours
- **BC-121N** MULTI-CHARGER + **AD-100** CHARGER ADAPTER (6 pcs.) + **BC-157S** AC ADAPTER  
For rapid charging of up to 6 battery packs (six AD-100's are required) simultaneously. An AC adapter may be supplied depending on version.  
Charging time: Approximately 2 to 2.5 hours
- **BC-152N** DESKTOP CHARGER + **BC-147S** AC ADAPTER  
Used for regular charging of battery pack. The same as supplied with the transceiver.  
Charging time: Approximately 10 hours
- **MB-86** SWIVEL BELT CLIP  
Swivel type belt clip. The same as supplied with the transceiver.

- **HM-138** SPEAKER-MICROPHONE  
Full-sized waterproof speaker-microphone including alligator type clip to attach to your shirt or collar, etc.
- **MB-98** BELT CLIP
- **MB-96F** LEATHER BELT HANGER  
For use with MB-98

Approved Icom optional equipment is designed for optimal performance when used with an Icom transceiver. Icom is not responsible for the destruction or damage to an Icom transceiver in the event the Icom transceiver is used with equipment that is not manufactured or approved by Icom.

Some options may not be available in some countries. Please ask your dealer for details.

# QUICK REFERENCE 15

Important operating instructions are summed up in this and the following page for your simple reference.  
By cutting along the line and folding on the dotted line, it will become a card sized operating guide which can easily be carried in a card case or wallet, etc.

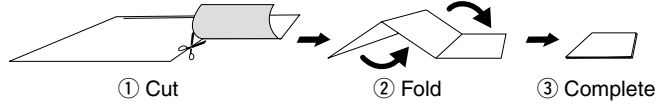

>CUT HERE<

## ICOM OPERATION GUIDE IC-M87

### ■ IN CASE OF EMERGENCY

#### ○ USING CHANNEL 16

- #### DISTRESS CALL PROCEDURE
1. MAYDAY MAYDAY MAYDAY.
  2. THIS IS (name of vessel)
  3. Your call sign or other indication of the vessel.
  4. LOCATED AT (your position)
  5. The nature of the distress and assistance required.
  6. Any other information which might facilitate the rescue.

### •CHANNEL SELECTION (pp. 8, 9, 16)



•Call channel  
Push [16] for 1 sec.



#### •International/USA/ATIS\* and LAND channels

\*German version only

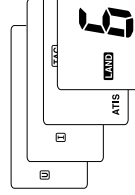
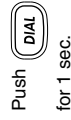

#### •Call channel programming (p. 12)

- ① Push [DIAL] for 1 sec. once or several times, to select the desired channel group.
- ② Push [16•C] for 1 sec. to select the call channel.
- ③ Push [16•C] for 3 sec. (until long beep changes to 2 short beeps)
- ④ Push [▲/▼] to select the desired channel.
- ⑤ Push [16•C] to program the displayed channel as the call

# 16 DOC

The following explanations are about the symbols on the attached Declaration of Conformity.



CE Versions of the IC-M87 which display the “CE” symbol on the serial number label, comply with the essential requirements of the European Radio and Telecommunication Terminal Directive 1999/5/EC and ATEX Directive 94/9/EC.



This warning symbol indicates that this equipment operates in non-harmonised frequency bands and/or may be subject to licensing conditions in the country of use. Be sure to check that you have the correct version of this radio or the correct programming of this radio, to comply with national licensing requirement.



## ■ SET MODE (pp. 17-21)

- 1 While pushing [SQL], turn power ON. 
- 2 Push [SQL] again to select an item. Refer to pp. 17-21 for set mode item.
- 3 Push [▲]/[▼] to select the desired condition.
- 4 Push [E•C] to return to regular operating mode.

## ■ DUAL/TRI-WATCH (p. 15)

- 1 Push [▲]/[▼] to select the desired channel.
- 2 Push [SCN•DUAL] for 1 sec. to start Dualwatch or Tri-watch depending on set mode setting (p. 19).

## ■ LOCK FUNCTION (p. 11)

- Push  for 1 sec. to turn the lock function ON and OFF. 

## ■ TAG CHANNELS (p. 14)

- 1 Push [▲]/[▼] to select the desired channel.
- 2 Push both [▲] and [▼] for 1 sec. to set the displayed channel as a TAG channel.

## ■ SCAN (p. 14)

- Push [SCN•DUAL] to start/stop scanning.

## ■ VOICE SCRAMBLER (p. 12)

- 1 Set a scrambler code in set mode (p. 21). 
- 2 While pushing and holding [SQL], push [SCN•DUAL] to turn the function ON and OFF. Cannot be used on ch. 16 or 70 channels.

**◇ Special conditions for safe use**

The equipment is an intrinsically safe equipment. It can be used in a potentially explosive atmosphere.

The equipment must be powered only by the battery Icom type BP-227AX.

When the transceiver is used in a hazardous areas, either the jack cover or HM-138 must be attached to the connector. Failure to do this will make the radio ATEX non-compliant and may result in an accident during use in hazardous areas.

The battery shall be charged only in non hazardous areas.

Ambient operating temperature: -20°C to +55°C

**◇ Meaning of ATEX marking codes**

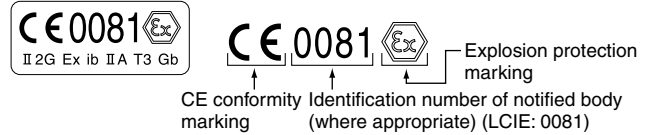

Equipment category:

1 (for Zone 0 or 20), 2 (for Zone 1 or 21), 3 (for Zone 2 or 22)

**II, 2G**

Type of Explosive atmosphere:  
G (for gas, vapors and mist), D (for dusts)

Equipment group: I (for mines), II (for other than mines)

Equipment conforms to types of protection standardized by CENELEC (European standards)

**Ex, ib, II A, T3, Gb**

Gas Group (see Fig. 1)

Intrinsic safety according EN60079-0 and EN60079-11

Gas/Equipment Protection Level (EPL)

Marking temperatures (see Fig. 1)

		Max. Temperature						
		T1: 450C	T2: 300C	T3: 200C	T4: 135C	T5: 100C	T6: 85C	
Gas Group	I	Methane	—	—	—	—	—	—
	IIA	Acetone	Ethyl alcohol	Benzine	Acetalde hyde	—	—	—
		Ethane	I-amyl acetate	Diesel fuel	Ethyl ether	—	—	—
		Ethyl acetate	n-butane	Aircraft fuel	—	—	—	—
		Ammonia	n-butyl alcohol	Heating oil	—	—	—	—
		Benzene (pure)	—	n-hexane	—	—	—	—
		Acetic acid	—	—	—	—	—	—
		Carbon Monoxide	—	—	—	—	—	—
		Methanol	—	—	—	—	—	—
		Propane	—	—	—	—	—	—
Toluene		—	—	—	—	—	—	
IIB	Town Gas (Coal Gas)	Ethylene	—	—	—	—	—	
	IIC	Hydrogen	Acetylene	—	—	—	—	
						Carbon disulphide	Ethyl nitrate	

(Fig. 1)

**Count on us!**

**< Intended Country of Use >**

AT BE CY CZ DK EE  
FI FR DE GR HU IE  
IT LV LT LU MT NL  
PL PT SK SI ES SE  
GB IS LI NO CH BG  
RO TR HR

A-6409H-1EU-⑨

Printed in Japan

© 2005–2013 Icom Inc.

Printed on recycled paper with soy ink.

**Icom Inc.**

1-1-32 Kamiminami, Hirano-ku, Osaka 547-0003, Japan