

11. TRANSMITTING AND RECEIVING

1 While holding down [PTT], speak into the microphone at your normal voice level.
 • The [TX/RX] indicator lights red while [PTT] is pushed.

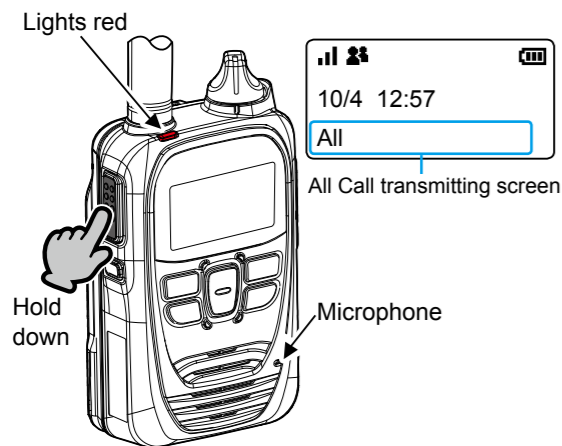

3 While receiving a call, push [PTT] to talk in the full duplex mode* like a telephone call.
 • In the Full Duplex mode, the [TX/RX] indicator lights orange.

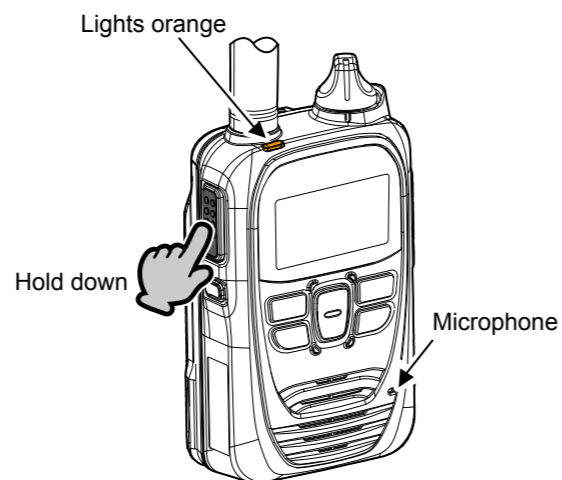

*Depending on a preset. Ask your dealer for detail.

2 When a Call is received, the [TX/RX] indicator lights green.

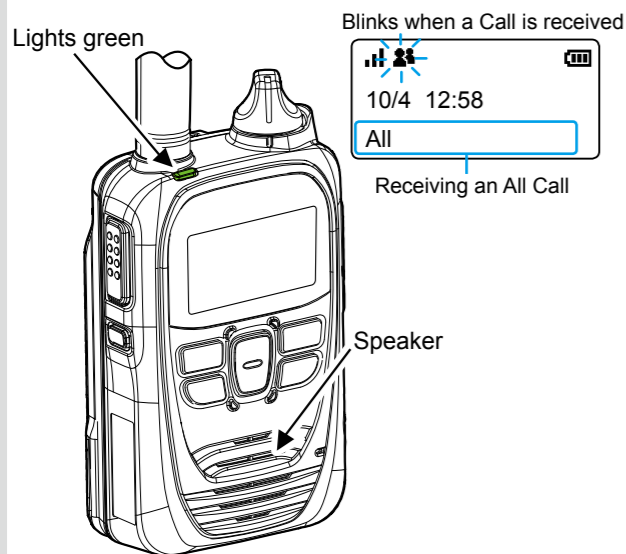

Turning OFF the power

Turn [PWR/VOL] maximum counter clockwise until it makes a "click" sound.



ICOM GUIDE

IP ADVANCED RADIO SYSTEM IP501H

Thank you for choosing the IP501H IP ADVANCED RADIO SYSTEM.
 READ ALL INSTRUCTIONS carefully and completely before using this product.

1. SUPPLIED ACCESSORIES

- Battery pack (BP-272) 1
- Belt clip (MB-135) 1
- Antenna 1
- Hand strap 1

2. PANEL DESCRIPTION

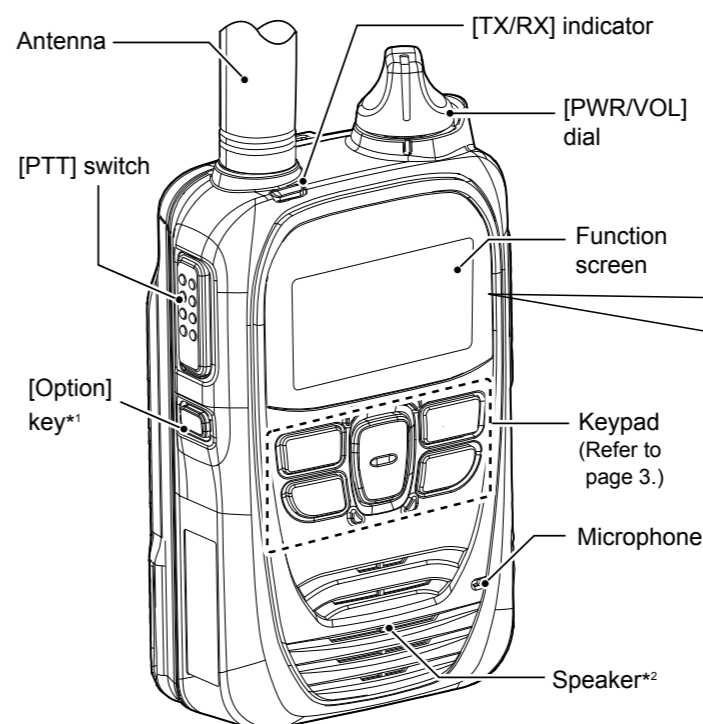

When connecting optional equipment

- Be sure to turn OFF the power before connecting or disconnecting optional equipment to or from the jack.
- Remove the cable by holding the plug not cable.
- Insert the plug securely when connecting the cable.

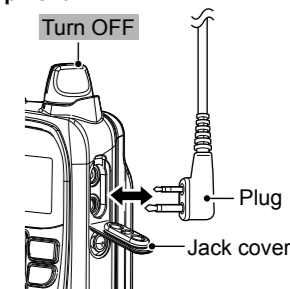

CAUTION: Attach the jack cover when no optional equipment is connected.

NOTE: Instructions and screens on this guide may differ, depending on the settings.

*1 Ask your dealer about the assigned function.
 *2 While connecting an optional speaker microphone, the audio is not output from the internal speaker.

3. ATTACHING THE BELT CLIP

① Remove the battery pack before attaching the belt clip.

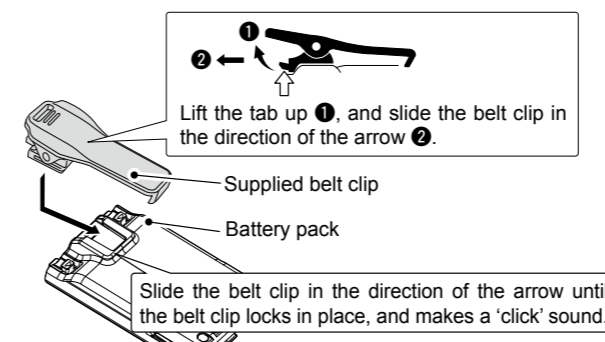

4. ATTACHING THE ANTENNA/HAND STRAP

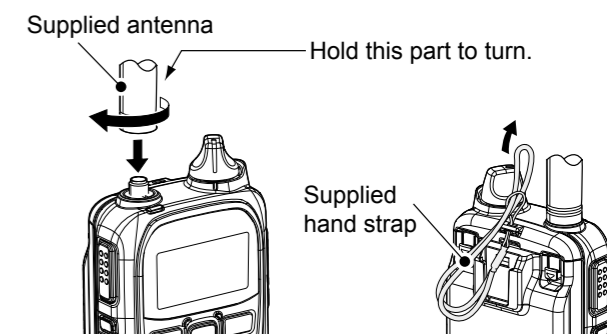

NOTE: You can use only the supplied antenna.

Icom, Icom Inc. and the Icom logo are registered trademarks of Icom Incorporated (Japan) in Japan, the United States, the United Kingdom, Germany, France, Spain, Russia, Australia, New Zealand and/or other countries.

Icom Inc.
 1-1-32 Kamiminami, Hirano-ku, Osaka 547-0003, Japan

Count on us!

5. ATTACHING THE BATTERY PACK

Follow the order (1 ~ 2) in the illustration below.

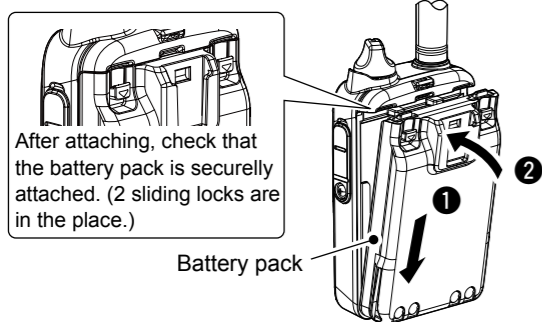

CAUTION

Even when the transceiver's power is OFF, a small current still flows in the transceiver. Remove the battery pack when not using it for a long time. Otherwise, the battery will become exhausted.

NOTE: Turn OFF the power before remove the battery pack in order (1 ~ 2) in the illustration to the right.

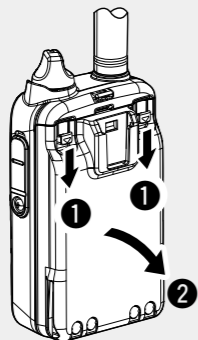

7. CHARGING THE BATTERY PACK (Using the BC-202IP2)

Fully charge the battery pack when the first time of use or has not been used for more than 2 months.

WARNING! NEVER charge the transceiver during a lightning storm. It may result in an electric shock, cause a fire or damage the transceiver. Always disconnect the power adapter before a storm.

- Turn OFF the transceiver power before charging. Otherwise, the battery may not be fully charged.
- Insert the transceiver (battery attached to the transceiver) into the charger as shown to the right.
- Charging indicator lights orange while charging. When the battery pack is fully charged, lights green. If the indicator blinks in orange, read the IP501H instruction manual on the Icom web site.
- The charger automatically restarts charging when the attached battery pack voltage drops.
- Disconnect the AC cable from the outlet when the charger is not in use.

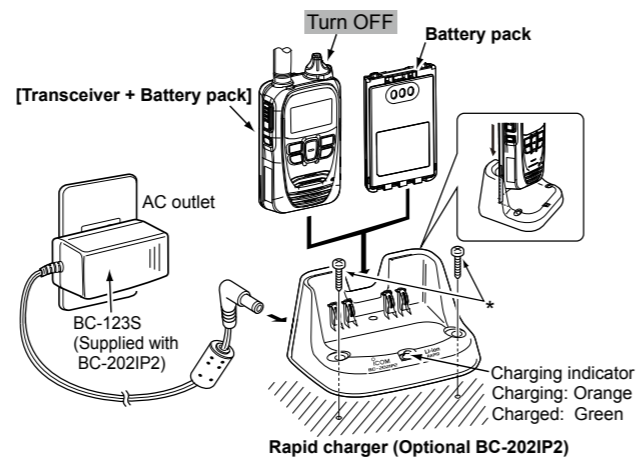

*Self-tapping screws (3.5x30 mm) (User supplied)

⚠ DANGER

- Use and charge only specified Icom battery packs with Icom transceivers or Icom chargers. Only Icom battery packs are tested and approved for use with Icom transceivers or charged with Icom chargers. Using third party or counterfeit battery packs or chargers may cause smoke, fire, or cause the battery to burst.
- Use the battery only with the transceiver for which it is specified. Never use a battery with any other equipment, or for any purpose that is not specified in this instruction manual.
- Read the "PRECAUTION" leaflet that is supplied with the IP501H, before attempt to charging the battery pack.

6. CHARGING TIME AND OPERATING TIME

NOTE: Operating time may be shorter, depending on the operating condition such as the roaming frequency. Frequently roaming makes the operating time shorter.

Battery	BP-272
Spec item	
Operating time	17 hours (approximately) TX:RX:Stand-by=5 : 5 : 90 (seconds)
Charging time	3.5 hours (approximately) Charging with the BC-202IP2

① The supplied battery pack is the BP-272.

- Immediately stop using the battery pack if it emits an abnormal odor, heats up, or is discolored or deformed. If any of these conditions occur, contact your Icom dealer or distributor.

About the remaining battery voltage indication

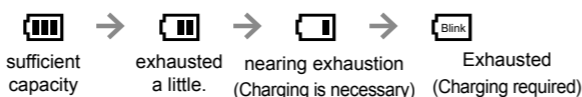

- ① When the battery charge is almost exhausted, the battery status indicator "□" starts blinking, and warning beeps sound every 30 seconds. Charge the battery pack immediately.
- ① When "LOW BATTERY" is displayed and beeps sound, the transceiver power will be automatically turned OFF soon.

① Instructions and screens in this guide may differ, depending on a preset.

8. TURNING ON THE POWER/ADJUSTING THE AUDIO LEVEL

Turning ON the power

- Turn [PWR/VOL] clockwise to the 12 o'clock position.
- A beep sounds.
- ① The dial rotation is made tight to resist dust and water intrusion.

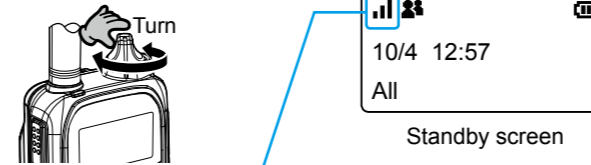

The signal strength is represented by 3 bars. In the 3G mode, the received signal strength is indicated by the ^{3G} icon. In the LTE mode, the ^{LTE} icon is displayed.

- ① When the transceiver location is out of the service area, or cannot receive the control signal, the (out-of-area) icon blinks.

Adjusting the audio output level

- Turn [PWR/VOL] to adjust the audio output level.
- The volume can be adjusted between 0 and 32.

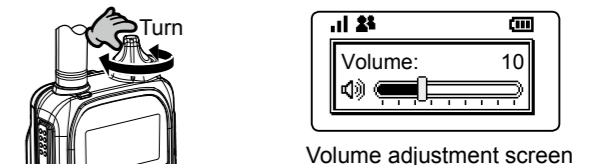

NOTE: If the output level is set to the minimum, the beep does not sound.

9. ABOUT THE KEY OPERATIONS

[Address] key*

Selects a calling party or group from this list. Push [▲]/[▼] to select "All Call," "Group Call" or "Individual Call."

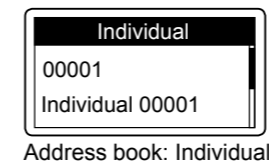

[Call history] key*

Selects the call history. Push [▲]/[▼] to select the "TX log," "RX log," "TX MSG log," "RX MSG log," "TX TEL log" or "RX TEL log."

- Hold down until "Emergency" is displayed to send an emergency call, depending on a preset.

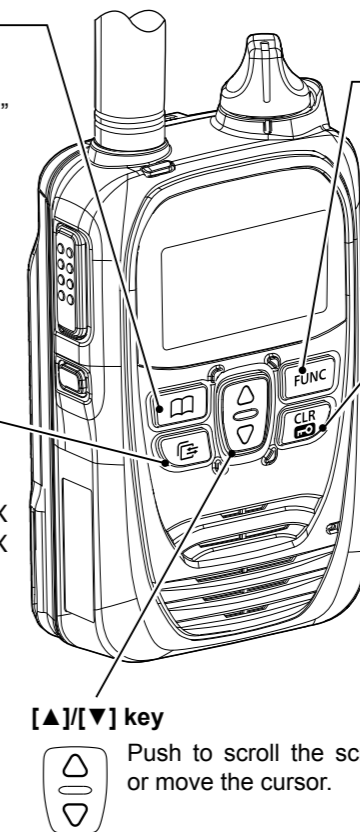

[FUNC] key*

Selects the message, Presence or Talk group to send.

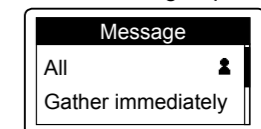

[CLR/LOCK] key

Push to return to the previous screen from a function screen. Hold down for 1 second to turn the Key Lock function ON or OFF.

- ① [PTT] switch and [PWR/VOL] dial can be used even while the Key Lock function is ON.



[▲]/[▼] key

Push to scroll the screen or move the cursor.

*May be usable, depending on a preset.

10. ABOUT THE CALL TYPES (CALLING PARTY)

Depending on a preset, you can select the calling party or group by pushing [Address]. Otherwise, you can call only preset party that is displayed on the stand-by screen.

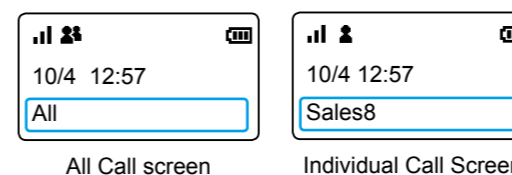

Calling Type Icons*1

- : All/Group Call
- : Talkgroup Call**
- : Individual Call
- : Phone Call**

**Blinks when a call or message is received.

**May be usable, depending on a preset.